



DC-DC CONVERTER TRANSFORMERS

FEATURES











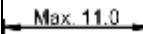

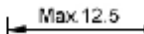





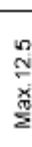
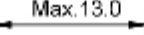

- I Application for DC/DC converter transformer, EL inverter transformer, driving transformer, switching regulators, etc..
- I A wide range of shapes and dimensions to meet with a variety range of output power requirements.
- I Bobbins also confirm to major electrical safety standard with harmonics current regulation.
- I Small leakage flux by adopting dispersed gap.

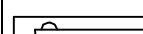
APPLICATIONS

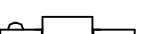
- I Pulse transformers, Drive transformers
- I Filters for communication equipment
- I Power converter, Computer

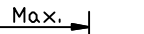





SPECIFICATION

1. Max. operating frequency
2. Max. power
3. Application

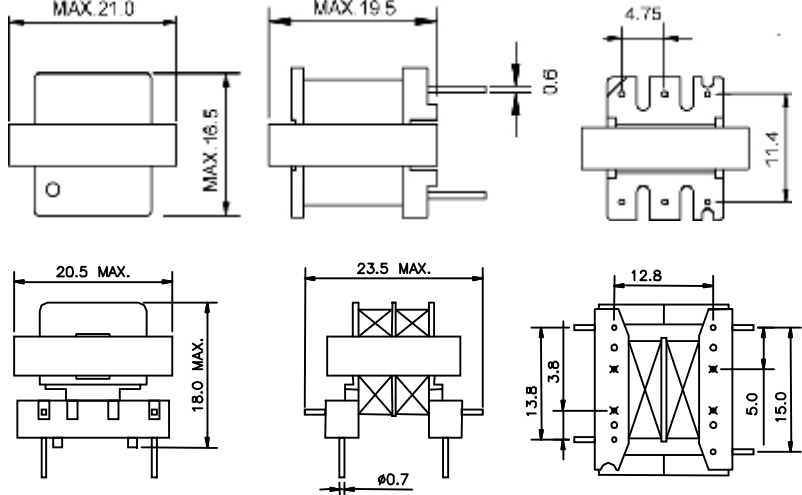
Model	Specification	Dimension (mm)		
EE10 	<ol style="list-style-type: none"> 1. Max. 300KHz 2. 3.2W 3. DC/DC converter, EL inverter, cameras 	 	 	 
EE13 	<ol style="list-style-type: none"> 1. Max. 300KHz 2. 4.6W 3. DC/DC converter, AC/DC adaptor 	 	 	 
EE16/EI16/EE16H 	<ol style="list-style-type: none"> 1. Max. 300KHz 2. 6W 3. Switching regulator, EL transformer, 	 	 	    

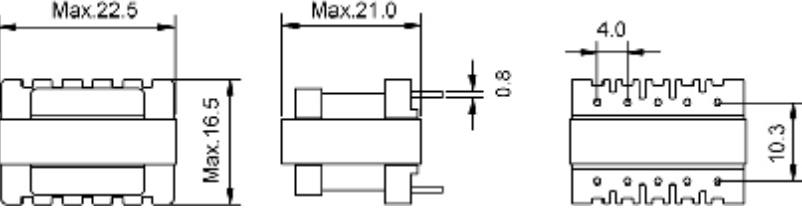

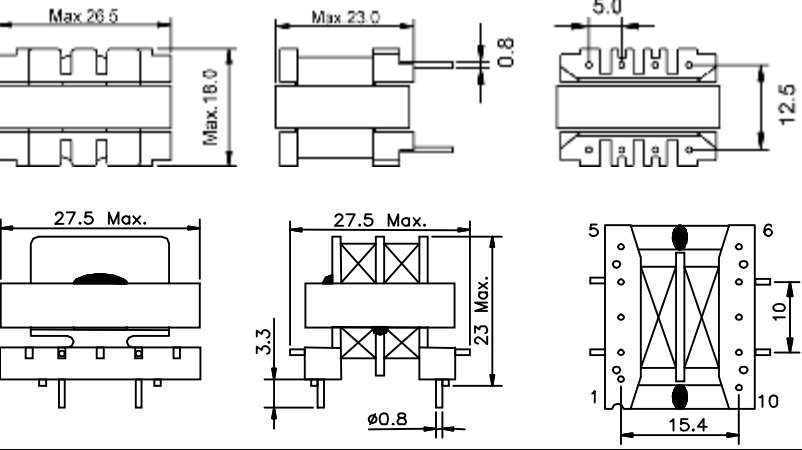
DC-DC CONVERTER TRANSFORMERS

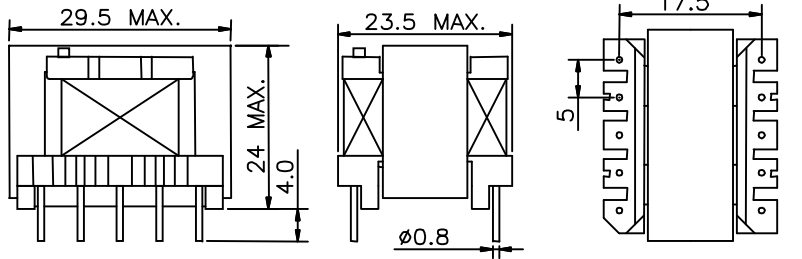
Model	Specification	Dimension (mm)
EE19/EI19/EE19H 	1. Max. 300KHz 2. 8W 3. Switching regulator, EL inverter, DC/DC converter, AC/DC adapter, Line filter(EE19H)	
EE22/EI22 	1. Max. 200KHz 2. 10W 3. DC/DC converter, AC/DC adapter	
EE25/EI25/EE25H 	1. Max. 200KHz 2. 16.8W 3. DC/DC converter, AC/DC adapter, Line filter(EE25H)	
EE28/EI28 	1. Max. 200kHz 2. 22.0W 3. Main transformer	

※ Specifications other than the above will be furnished upon request.



DC-DC CONVERTER TRANSFORMERS

SPECIFICATION

1. Max. operating frequency
2. Max. power

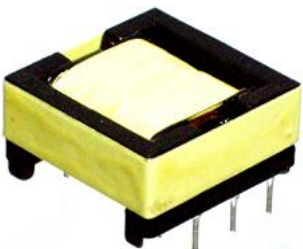
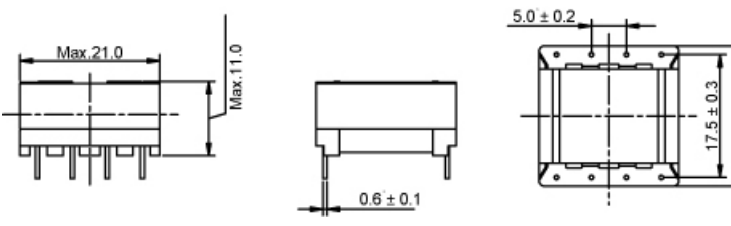
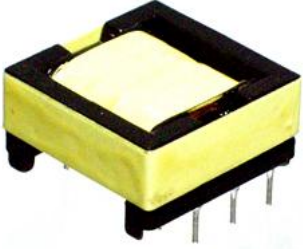
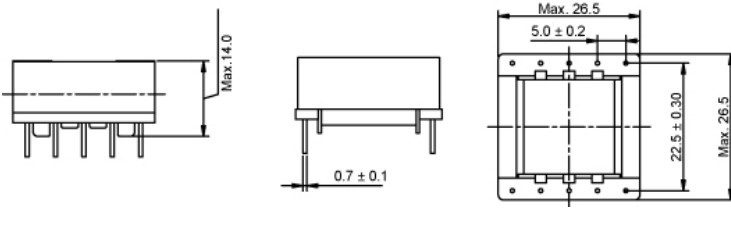
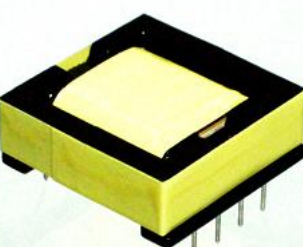
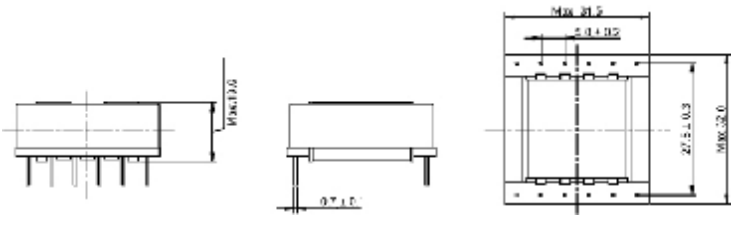
Model	Specification	Dimension (mm)
EFD20 	1. Max. 200KHz 2. 11.8W	
EFD25 	1. Max. 200KHz 2. 18W	
EFD30 	1. Max. 200KHz 2. 28.6W	





※ Specifications other than the above will be furnished upon request.

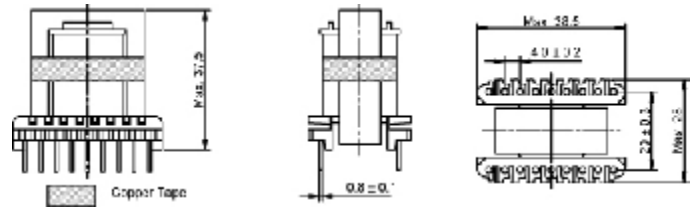

DC-DC CONVERTER TRANSFORMERS

SPECIFICATION

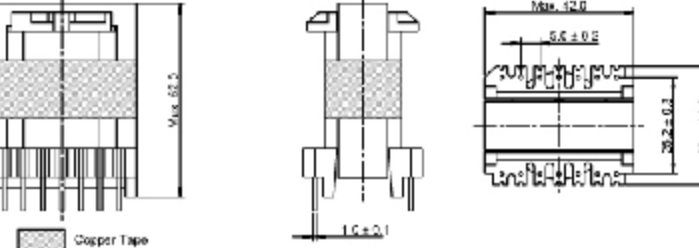
3. Max. operating frequency
4. Max. power

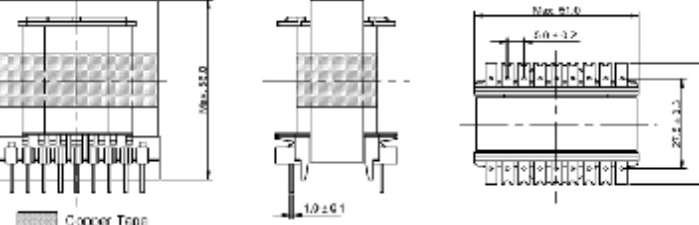
Model	Specification	Dimension (mm)
ER28 	1. Max. 200KHz 2. 32W	
ER39 	1. Max. 200KHz 2. 45W	
ER49 	1. Max. 200KHz 2. 60W	

※Specifications other than the above will be furnished upon request.